

CHINA'S LEADING HINGEND FUBER LASER BRAND

HAN  S PHOTONICS

SENZHEN HAN'S PHOTONICS TECHNOLOGY CO. LTD.

High Power Fiber Laser

HPFL-R4000-G3

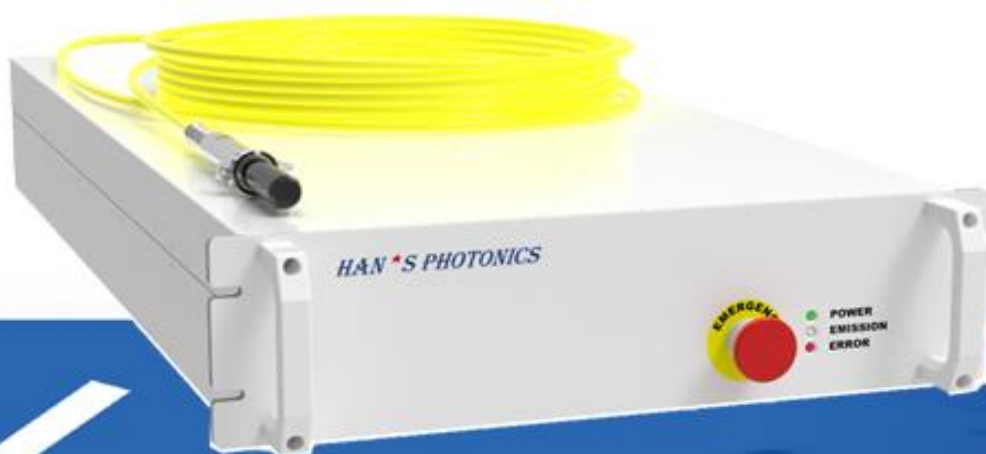

EDITION : 3.0

*以上产品外观仅为参考，涉及产品型号规格及技术指标如有变更，恕不另行通知，敬请谅解。

Sales Hotline : 400-666-4000 Official Site: www.hanslaser.com

Company Address: Han's Laser global production base, No.128, Chongqing Road,
Fuhai Street, Baoan District, Shenzhen



DISCLAIMER

Han's Photonics makes no representations or warranties with respect to this manual and, to the maximum extent permitted by law, expressly limits its liability for breach of any warranty that may be implied to the replacement of this manual with another. Furthermore, Han's Photonics reserves the right to revise this publication at any time without incurring an obligation to notify any person of the revision.

The information provided in this documentation contains general descriptions and/or technical characteristics of the performance of the products contained herein. This documentation is not intended as a substitute for and is not to be used for determining suitability or reliability of these products for specific user applications. It is the duty of any such user or integrator to perform the appropriate and complete risk analysis, evaluation and testing of the products with respect to the relevant specific application or use thereof. Neither Coractive nor any of its affiliates or subsidiaries shall be responsible or liable for misuse of the information that is contained herein. If you have any suggestions for improvements or amendments or have found errors in this publication, please notify us.

All pertinent state, regional, and local safety regulations must be observed when installing and using this product. For reasons of safety and to help ensure compliance with documented system data, only the manufacturer shall perform repairs to components.

Failure to observe this information can result in injury or equipment damage.

Copyright © Han 's Laser Technology Industry Group Co., LTD. All rights reserved.

Product Compliance



All rights reserved. No part of this publication may be reproduced, distributed, or transmitted in any form or by any means, including photocopying, recording, or other electronic or mechanical methods, without the prior written permission of the publisher.

For permission requests, write to the publisher, addressed "Attention: Product line Manager,"

This product is CE marked and complies to the EMC directive 2014/30/EU to ensure that electrical and electronic equipment does not generate, or is not affected by, electromagnetic disturbance. The product must be used and installed according to this user guide.



This device is classified as a high-power Class IV laser instrument under IEC 60825-1:2007 and 21 CFR 1040.10. This laser module is designed for OEM applications and integration into other equipment. It does not comply with all requirements of the laser product in terms of IEC 60825 and 21 CFR 1040.10. The manufacturer/integrator of the laser system is responsible for the final safety compliance according to the applicable standards and regulations in the targeted jurisdiction.

This device must not be treated as unsorted municipal waste but must be collected separately! Dispose of the device via a collection point for the recycling of waste electrical and electronic



equipment if you live within the EU and in other European countries that operate separate collection

systems for waste electrical and electronic equipment. By disposing of the device in the proper manner, you help to avoid possible hazards for the environment and public health that could otherwise be caused by improper treatment of waste equipment.



The recycling of materials contributes to the conservation of natural resources.

Therefore, do not dispose of your old electrical and electronic equipment with the unsorted municipal waste.

If you do not live in the EU, refer to your local regulations for electronic equipment.

CATALOGUE

DISCLAIMER	2
Product Compliance.....	2
FOREWORD.....	6
Welcome	6
Edition statement.....	6
Description of the User	6
Retaining Instructions	6
1 PREFACE	7
1.1 Receiving inspection.....	7
1.2 Precautions for unpacking	7
1.3 Precautions for unpacking	7
1.4 Installation and protection	7
2 SAFETY REQUIREMENT.....	9
2.1 Safety warning signs and instructions.....	9
2.2 Laser safety notice	11
2.3 Electrical safety.....	12
2.4 Other safety precautions	12
3 PRODUCT OVERVIEW	13
3.1 Overview	13
3.2 Product appearance and size	13
3.2.1 Laser size diagram	13
3.2.2 Front panel introduction	14
3.2.3 Rear panel introduction.....	15
3.2.4 Laser head output size and physical object	16
3.3 Laser technical parameters and specifications.....	18
3.4 Environment and conditions of use.....	19
3.5 Power connection.....	20
3.6 The pins are defined as below:.....	21
3.7 Laser Remote Control.....	23
4 UPPER COMPUTER SOFTWARE USE.....	24
4.1 Network Port Settings	24
4.2 Preparation and inspection before use	25
4.3 Operation interface introduction and on/off procedures.....	25
4.3.1 Switching operation pages	26
4.3.2 Real-time power display area	26
4.3.3 Laser status display area	26
4.3.4 Laser frequency setting area Laser power adjustment area.....	26
4.3.5 Laser power control area.....	26
4.3.6 Laser control command operation area.....	27
4.3.7 Laser operation flow.....	27
4.4 Status interface.....	28

5 MAINTENANCE AND TROUBLESHOOTING 29

FOREWORD

Welcome

Thank you for purchasing Shenzhen Han's Photonics Technology Co., LTD. Single module 6000W continuous fiber laser. If you are using this product for the first time, please be sure to read this instruction manual carefully before installation and use.

Edition statement

This document is Simplified Chinese version 3.0, only applicable to the standard configuration of the corresponding product model, and describes the working principle, installation method, operation and use, troubleshooting, transportation, storage, and maintenance of the product. If you are using this product for the first time, please read this information carefully before installation and use. Please keep this information safe for future reference

Description of the User

This product is intended to be used by skilled integrators in a complete system. The integrator must have technical knowledge in electronics and laser safety for the proper and safe operation of this product. It is the responsibility of the laser integrator to provide the full information of operation and safety to the end user of their complete system.

This product may be used for research and development purposes by skilled personnel trained in electronics and in laser safety.

Retaining Instructions

Read and understand this manual and its safety instructions before using this product. Failure to do so can result in serious injury or death.

Follow all the instructions. This will avoid fire, explosions, electric shocks, or other hazards that may result in damage to property and/or severe or fatal injuries.

The product shall only be used by persons who have fully read and understand the contents of this user manual.

Ensure that each person who uses the product has read these warnings and instructions and follows them.

Keep all safety information and instructions for future reference and pass them on to subsequent users of the product.

The manufacturer is not liable for cases of material damage or personal injury caused by incorrect handling or non-compliance with the safety instructions. In such cases, the warranty will be voided.

1 PREFACE

1.1 Receiving inspection

In order to ensure that the laser can be fully protected during transportation, the packaging box specially designed for this product can protect the product from being damaged to the maximum extent. However, unpredictable situations may occur during the transportation process, and users still need to carefully check whether the packing box is correctly placed before unpacking, and whether there is any damage or phenomenon such as collision, cracking and flooding outside the box. Keep the packing case and internal filler materials.

1.2 Precautions for unpacking

When taking out the laser, take care to avoid collision or violent vibration of the laser. Remove the coiled output fiber and excitation. When the optical output head is used, special attention should be paid to not twisting, bending, or pulling the laser output fiber, and the laser output head should be avoided from collision and vibration.

1.3 Precautions for unpacking

When taking out the laser, take care to avoid collision or violent vibration of the laser. When taking out the coiled output fiber and the laser output head, pay special attention to not twisting, bending, pulling the laser output fiber, and avoid collision and vibration of the laser output head.



The output cable and output head of the laser are precision optical devices, and the distortion or excessive bending of the output cable and the vibration and impact of the laser output head will cause irreparable damage to the laser.

1.4 Installation and protection

In order to avoid the environment to bring unstable factors to the machine, the installation should be placed smoothly to avoid vibration and impact. Temperature and humidity refer to the operating environment. Do not expose this product to too much moisture.





Do not expose the product to a dusty environment, and the end face of the optical fiber output end must always be kept clean. When not in use, the original protective cover should be re-covered to keep it clean. Do not touch the end face of the optical fiber end, and use a cotton swab dipped in 99.99% isopropyl alcohol to clean the end face under a microscope.

Before turning on the power switch, ensure that the laser output head is securely secured in the terminal device (such as an external optical head, laser power meter, or laser collection device).

2 SAFETY REQUIREMENT

2.1 Safety warning signs and instructions

In order to prevent possible injury to the human body or damage to the device, use the following safety symbols to indicate the information. When using the device, pay attention to the contents of the symbols to ensure the safety and correct use of the device.

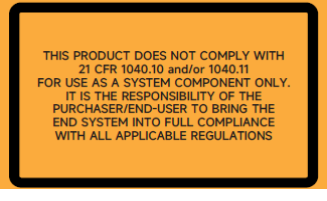
	<p>Laser radiation attention content, there is a danger of laser radiation, please take laser protection measures!</p>
	<p>Electrical safety precautions may cause the risk of electric shock, resulting in personal injury!</p>
	<p>General Precautions. If you do not follow these instructions, personal injury or equipment damage may occur.</p>
	<p>safety ground.</p>
 <p>MAX AVERAGE OUTPUT POWER: 6kW CW WAVELENGTH RANGE: 900-1200nm</p>	<p>Laser output power and wavelength.</p>
 <p>THIS PRODUCT DOES NOT COMPLY WITH 21 CFR 1040.10 and/or 1040.11 FOR USE AS A SYSTEM COMPONENT ONLY. IT IS THE RESPONSIBILITY OF THE PURCHASER/END-USER TO BRING THE END SYSTEM INTO FULL COMPLIANCE WITH ALL APPLICABLE REGULATIONS</p>	<p>Purchase or use the end user in full compliance with all applicable regulations.</p>

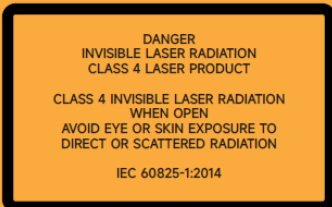
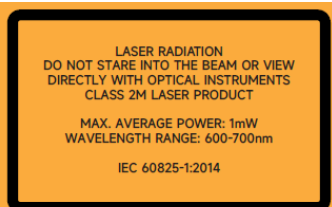
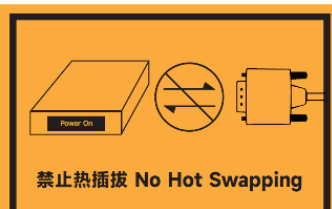
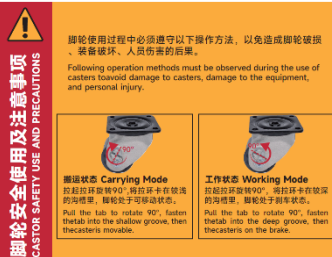
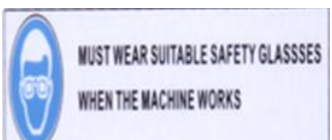
	<p>Avoid contact. Do not look directly at the laser output!</p>
	<p>Dangerous Class IV invisible laser products. When opened directly or by scattering or radiation, avoid eye or skin exposure.</p>
	<p>Do not use optical instruments to look directly at the beam or at 2m laser products. MAX Indicates the wavelength range of the average power</p>
	<p>Do not hot swap DB interfaces.</p>
	<p>When using casters, observe the following operations to avoid caster damage, equipment damage, and personal injury.</p>
	<p>Protective glasses warning.</p>

2.2 Laser safety notice

The laser radiation is not visible, and direct or indirect exposure to such light intensity can cause damage to the eyes and skin, and the laser beam can cause irreparable damage to the retina or cornea. Therefore, it is necessary to wear the appropriate band and certified laser protective glasses at all times during the operation of the laser.

	<p>Even if you wear laser safety glasses, do not look directly at the laser output head when the laser is powered on (whether it is powered on or not).</p>
---	---

	<p>Laser output head</p>	<p>Ensure that the protective cap of the laser output head is removed before the light is turned on. Otherwise, the protective cap will be burned, and the lens or crystal of the laser output head will be burned</p>
		<p>Check and clean the end face of the output head. Do not output the laser when the protective cap of the laser output head is not opened. Otherwise, the lens or crystal of the laser output head will be burned</p>
		<p>When winding the output fiber and laser output head, pay special attention to not excessive distortion, bending, pulling, otherwise it will cause damage to the laser output head and fiber.</p>
<p>Radius of an optical fiber disk</p>	<p>The minimum bending radius of the transmission fiber shall not be less than 20CM in the non-working state such as transportation and storage, and the minimum bending radius shall not be less than 30CM in the working state of the laser</p>	

2.3 Electrical safety

1) Verify that the grounding is safe and reliable.

	Using 360V ~ 440VAC, 50/60Hz, three-phase four-wire connection, wrong wiring or power supply voltage will cause irreversible damage to the laser.
---	---

2) All cables and connectors must be connected in the event of power failure to ensure that the AC voltage is consistent with the specified specifications.

	If the grounding of the product is interrupted, the product cover will be charged, which may cause personal injury to the operator.
--	---

3) In order to avoid the possibility of fire, if the safety tube needs to be replaced, the same type should be selected, and other safety tubes are prohibited.

2.4 Other safety precautions

1) When the laser is stored in a temperature environment below zero, the water in the laser water channel should be completely released to prevent the internal water channel from freezing and cracking.

2) When the laser is running, please wear a good band and certified protective glasses, do not look directly at the laser output head.

3) Do not use the fiber laser in a dim or dark environment. After the device is powered on and before the laser shines, use the red indicating beam to confirm the laser light position to prevent safety accidents.

4) Please strictly follow the product instructions to operate the laser, otherwise any damage to the laser will not be guaranteed.

5) The product has no built-in accessories, do not try to open the product cover, otherwise it may cause contact damage, and the warranty is invalid. All repairs should be carried out by large personnel, in order to prevent electric shock, please do not damage the label or remove the lid, otherwise any damage to the product will not be guaranteed.

3 PRODUCT OVERVIEW

3.1 Overview

Compared with traditional lasers, fiber lasers have higher photoelectric conversion efficiency, lower power consumption and better beam quality. Fiber laser has compact structure, stable power and flexible laser output mode, which makes the laser competent for multi-dimensional arbitrary space processing applications and convenient for mechanical system design.

3.2 Product appearance and size

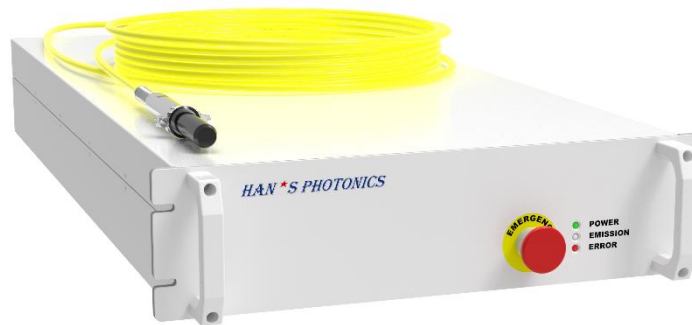

3.2.1 Laser size diagram

The following is the laser appearance size diagram. Width × height × depth: 485×120×910mm

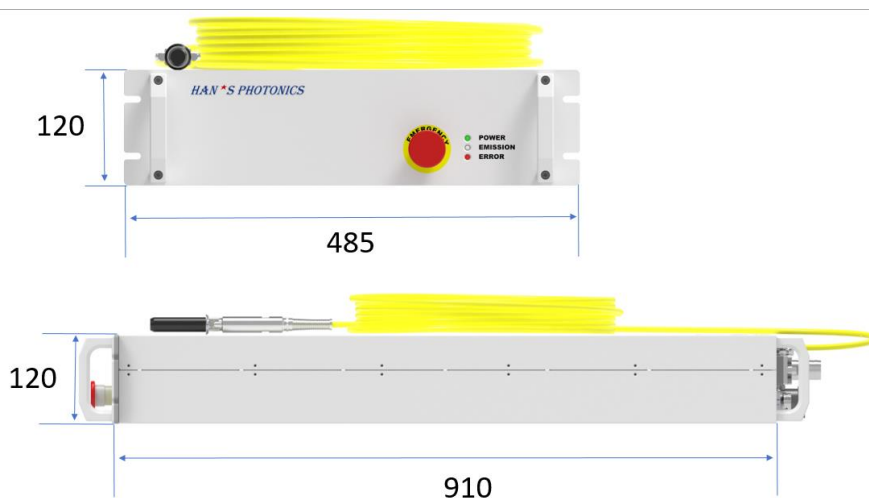

3.2.2 Front panel introduction

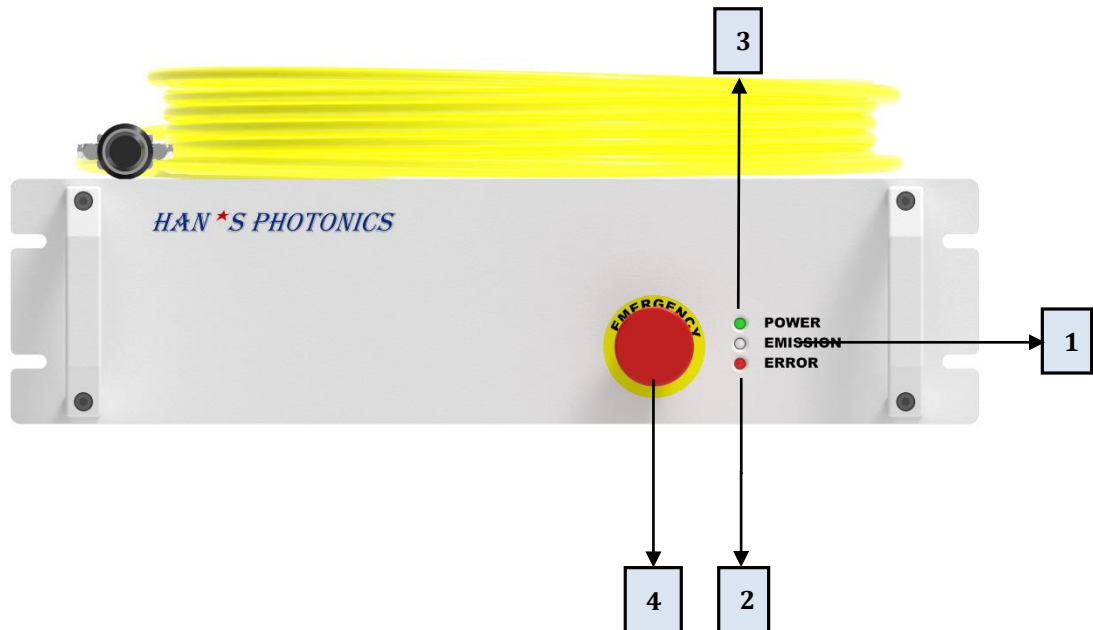

ITEM	描述
1. EMISSION	Laser light out indicator: If the light is on, the light is out. The red light is off.
2.ERROR	Alarm light: When there is an alarm, this light is on, and the white light is not on.
3.POWER	Power indicator: After power-on, turn on the power switch and turn on the high voltage.
4.EMERGENCY	Emergency stop button: Press to turn off and lock the laser immediately. Turn clockwise to release the button and resume normal operation.

3.2.3 Rear panel introduction

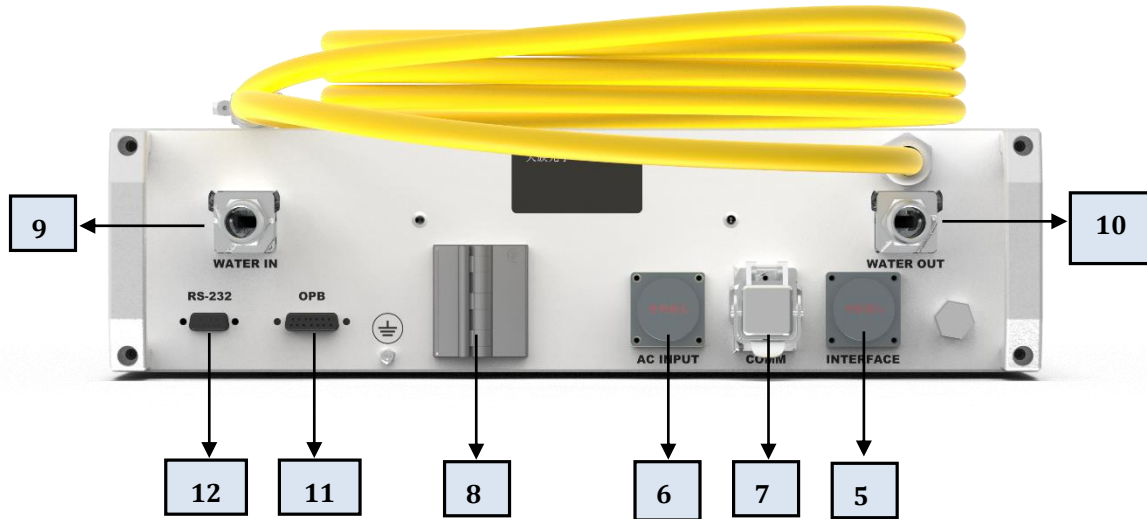

ITEM	描述
5.INTERFACE	External control interface, multifunctional interface, the user can set the control mode, input analog voltage signal, but also the fault signal output.
6. AC INPUT	Three-phase ac socket
7.ETHERNET PORT	The network port connects the computer to the upper computer for communication.
8.SWITCH	miniature circuit breaker
9.L WATER IN	Low temperature water, 25°C input.
10. L WATER OUT	Low temperature water, 25°C output.
11.OPB	Reserve
12.RS-232	Reserve

3.2.4 Laser head output size and physical object

The laser output head of the laser product is the QBH output head, the specific appearance size is as follows:

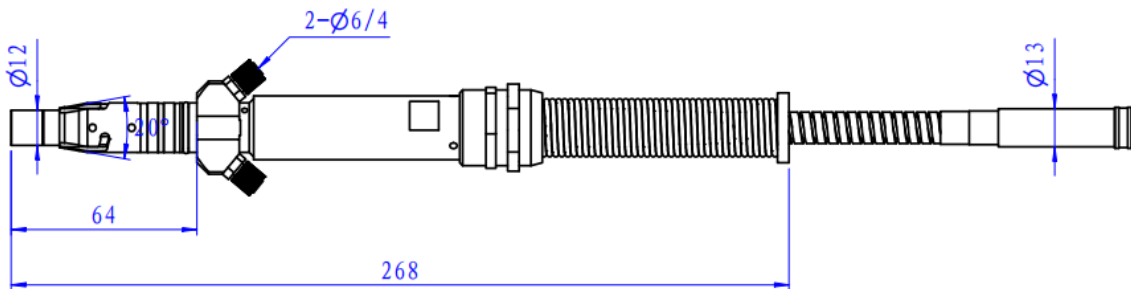

QBH output head physical:

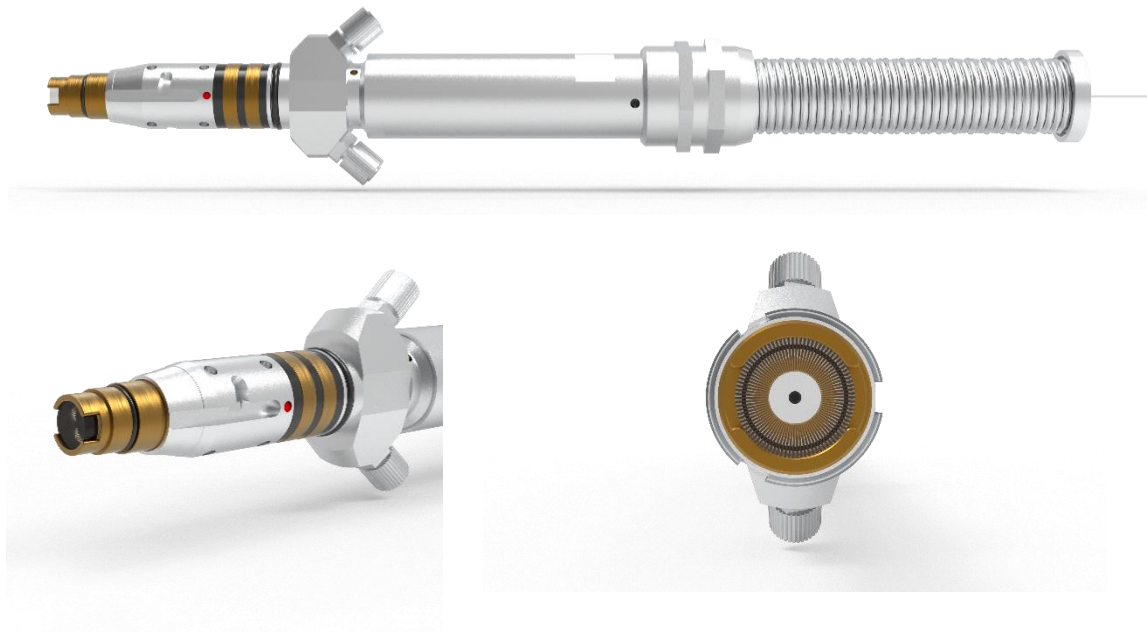

	<p>For the QBH laser output head, the output first two copper contacts (Interlockpins) must be shorted before the laser works, otherwise the laser will not work properly.</p>
	<p>The lens of the laser output head must be checked before mounting the output head to the external device. If the laser output head lens is found to be unclean, the lens must be cleaned.</p>

When the mirror of the QBH output head appears the following situation, please stop using!

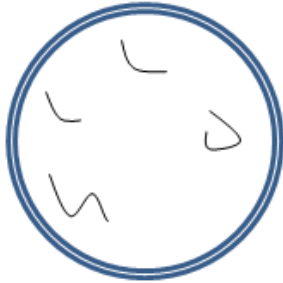
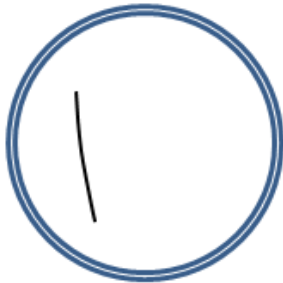
The following conditions may cause damage to the quartz head		
		
Surface damage	Coating damage	Surface scratch

3.3 Laser technical parameters and specifications

Model		HPFL-4000-G3-A- QH034/10	HPFL-4000-G3-A- QH050/20	HPFL-4000-G3-A- QH100/20
Optical characteristics	Unit			
Rated output power (continuous)	W	4000		
Central wavelength	nm	1080±10		
Adjustable power range	%	10-100		
Power stability	%	< ±1		
Operation mode	/	CW/Modulated		
Polarization state	/	Random		
Max. modulation frequency	kHz	5		
Red light laser output power	mW	> 0.5		
Output fiber core diameter	μm	34 (customized)	50 (customized)	100 (customized)
Beam quality	BPP	≤1.0	≤2.0	≤4.0
Connector type	/	QBH		
Delivery cable length	m	10 (customized)	20 (customized)	
Weight	Kg	< 75		

3.4 Environment and conditions of use

Name of parameter	Unit	Numerical value
Power supply	VAC	360-440VAC, 50/60Hz, 3-phase 4-wire
Power consumption	W	12000
Refrigerating capacity	W	> 9000
Maximum input pressure	Bar	4
Low temperature water flow	L/min	> 50
QBH Water flow	L/min	3
Low temperature water pipe dimensions	mm	Inside diameter 25
QBH water pipe size	mm	Outside diameter 6, inside diameter 4
Ambient humidity	°C	10-40
Ambient humidity	%	< 75
Security environment		Flat installation, no vibration and impact

The basic operating environment requirements of the product are as follows:

The following table is the corresponding temperature/humidity relationship of the product for reference, and the specific situation shall prevail:

周围环境露点										
环境温度	环境湿度									
	10%	20%	30%	40%	50%	60%	70%	80%	90%	95%
10°C	-20.0	-11.9	-6.8	-3.0	0.6	2.6	4.8	7.6	8.4	9.2
15°C	-16.4	-7.9	-2.4	1.5	4.7	7.3	9.6	11.6	13.4	14.2
20°C	-12.5	-3.7	1.9	6.0	9.3	12.0	14.4	16.4	18.3	19.2
25°C	-8.7	0.5	6.2	10.5	13.8	16.7	19.1	21.3	23.2	24.1
30°C	-5.0	4.6	10.5	15.0	18.4	21.4	23.9	26.2	28.2	29.1
40°C	2.6	12.7	19.1	23.8	27.6	30.7	33.5	35.9	38.0	39.0
50°C	10.0	20.8	27.6	32.6	36.7	40.0	43.0	45.6	47.9	49.0

	<p>Running in a high temperature environment will accelerate the aging of the laser, resulting in an increase in the threshold current and a decrease in the conversion efficiency. If the laser is overheating, stop using it immediately and contact the after-sales support team</p>
	<p>Check the water circulation system regularly every week to ensure that the water flow is smooth.</p>
	<p>Before the laser is running, run the water first and then power on. When the laser is off, run the power first and then cut off the water.</p>

3.5 Power connection

Input voltage	360V ~ 440VAC, 3P+PE
Input current	20A (MAX)
Frequency	50/60Hz

	<p>When connecting the AC power supply, use the external cable with the terminal to connect the main power switch. Do not connect the main power switch with bare cables</p>
---	--

3.6 The pins are defined as below:

引脚号	名称	输入输出	功能描述
1	LOCK1+	Input	The laser external interlock input signal needs to use passive contacts to close 1-3, 2-4, the laser considers the external environment is safe, allow the laser main power supply to power on, otherwise do not allow the laser main power supply to power on
2	LOCK2+	Input	
3	LOCK2-	Input	
4	LOCK1-	Input	
5	POWERFB+	Input	The current output power state of the laser indicates the analog quantity, 0V corresponds to 0 power, 7V corresponds to 100% rated power value, and the maximum output is 10V
6	POWERFB-	Input	Laser power feedback simulates quantitatively
7	NC		Reserve
8	NC		Reserve
9	NC		Reserve
10	NC		Reserve
11	PE		PE
12	ANALOG+		Laser power control analog, range 1V-10V, 1V corresponds to 10% power, 10V corresponds to 100% power
13	PWM_5V		Input positive pulse signal. If the drive signal amplitude is 5V, connect to pin 20; if the drive signal is 24V, connect to pin 19, and cannot be input at the same time. ($4.5V \leq V \leq 5.5V$, $I \leq 10mA$)
14	ANALOG-		Laser power control analog, range 0V-10V, 1V corresponds to 10% power, 10V corresponds to 100% power

15	PWM_24V	Input	Input positive pulse signal, if the drive signal is 24V, connect pin 19. ($20V \leq V \leq 28V$, $I \leq 10mA$)
16	PWM_0V		Connected to PWM signal common ground terminal 0V (with 19-pin or 20-pin)
17	RED	Input	In the external control state, input a continuous 24V signal ($20V \leq V \leq 28V$, $I \leq 10mA$) to turn on the laser guiding red light
18	ENABLE	Input	In the external control state, add a continuous 24V signal ($< 10mA$) to the pin to enable the laser
19	SHUTTER	Input	In the external control state, add a continuous 24V signal ($< 10mA$) to the pin to open the electronic light gate
20	ISO_GND		Digital Ground Signal (ISO GND)
21	RESET	Input	The external control state adds a pulse ($> 100ms$) 24V signal ($< 10mA$) to the pin to reset the laser alarm
22	ERROR	Output	The output of a continuous 24V signal ($< 10mA$) indicates that the current laser is in an error state
23	READY	Output	The output of a continuous 24V signal ($< 10mA$) indicates that the laser is currently in the ready state
24	EMISSION_ON	Output	The output of a continuous 24V signal ($< 10mA$) indicates that the current laser is in the light state

Note: ISO_GND laser externally controlled digital ground signal and externally controlled laser analog ground -(AGND), reflection detection analog -, laser power feedback analog - are independent ground. If the externally controlled digital ground signal of the machine tool is the same as the externally controlled laser analog ground -(AGND), reflection detection analog -, and laser power feedback analog -, it is necessary to short-circuit the laser ISO_GND and externally controlled laser analog ground -(AGND), reflection detection analog -, and laser power feedback analog -.

3.7 Laser Remote Control

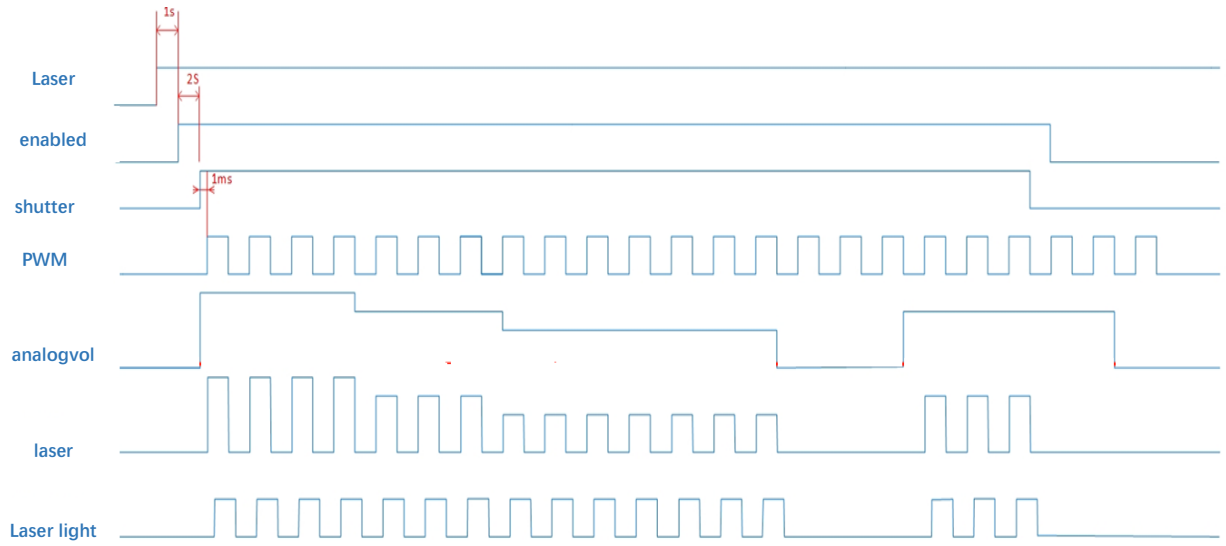

4 UPPER COMPUTER SOFTWARE USE

4.1 Network Port Settings

The laser and the operating interface use the standard network communication mode. The positions of network ports are shown in rear panel 8. The default IP address of the laser is 192.168.0.7. Enter the IP address as shown in the figure and then click "Confirm", you can jump out of the network connection option, directly enter the laser connection interface, the next login will automatically record the last entered IP address.

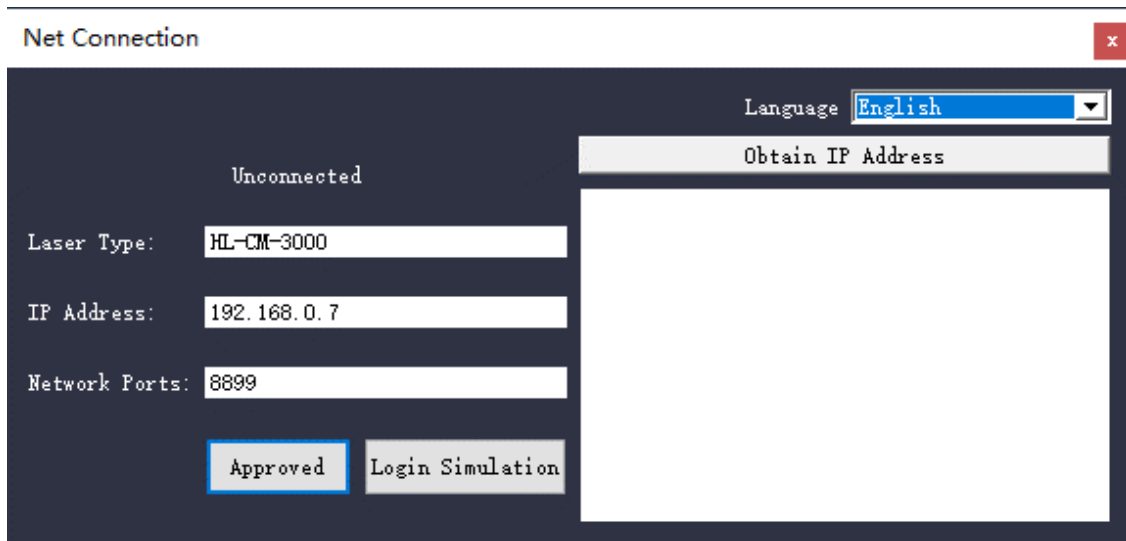

Set the following parameters on the local PC: IP address: 192.168.0.xxx (xxx cannot be set to the IP address of the laser). Subcode mask: 255.255.255.0; Default gateway: 192.168.0.1

4.2 Preparation and inspection before use

The laser can be debugged by setting out the light on the upper computer. When the frequency is set to 1KHZ and the duty cycle is 100%, the laser is continuously emitting light, and the user can control the output power of the laser by setting the power percentage. In modulation mode, set the frequency, duty cycle and power percentage to set the optical waveform.

Before powering on the laser, check whether the laser status meets the following requirements:

- 1) The power cord and control line are connected correctly and the voltage meets the product requirements.
- 2) The start button switch and the emergency stop switch are in the off position.
- 3) The water cooling system is connected, the chiller starts to work and the water temperature is already at the appropriate working temperature (about 25 ° C), and check whether the entire waterway system and joints are leaking.
- 4) Whether the laser is properly connected to the computer on the operation interface, and whether the IP address of the computer is set reasonably. (For the setting method, see 5.5 Network Interface Settings.)

4.3 Operation interface introduction and on/off procedures

Open the micro circuit breaker on the rear panel and power on the laser. If everything is normal, open the upper computer software of the HL-Monitor series and set the network interface according to 5.5, you can enter the following interface.

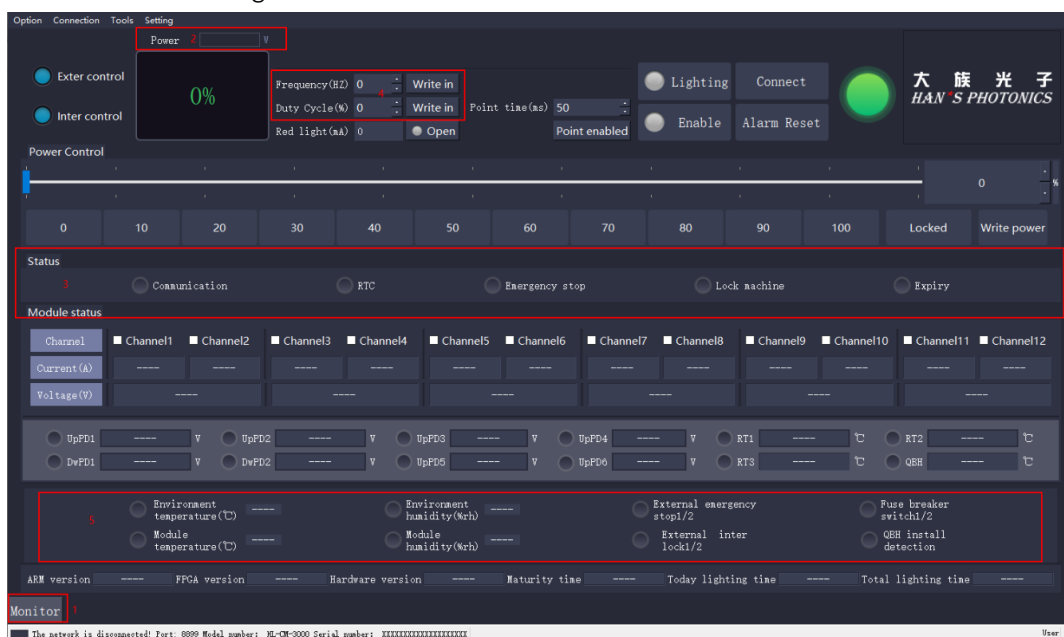

4.3.1 Switching operation pages

the position of ① in the figure is the operation interface;

4.3.2 Real-time power display area

the power output value of the current laser at the location (2) in the figure;

4.3.3 Laser status display area

The area shown by (3) in the figure is the laser status monitoring area. You can view the current status information of the laser. Green indicates normal, yellow indicates warning;

4.3.4 Laser frequency setting area Laser power adjustment area

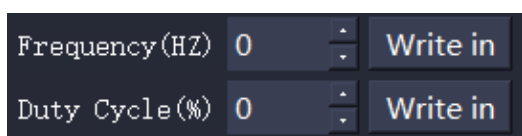

In the single line box of the modulation frequency, fill in the appropriate frequency, and then click the button to write the required frequency into the laser, similarly, in the single line box of the duty ratio, fill in the appropriate duty ratio, and click the button to write the required duty ratio into the laser.

4.3.5 Laser power control area

Three modes of operation

1. Pull the pole directly to set the power control percentage;

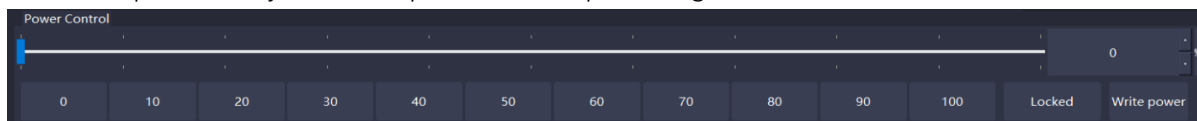

2. Click the button to directly select the corresponding power control percentage;

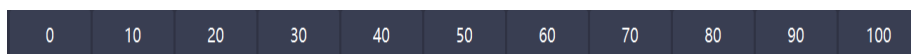

3. Power control box input the corresponding power percentage, and then click Enter or lock button;

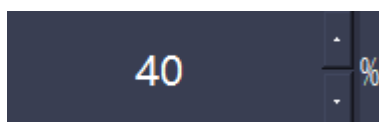

4.3.6 Laser control command operation area

If the current control mode is remote control, the buttons in this row will not operate. It can be operated only when the laser is in the internal control state.

Enabled: Turn on/off the switch power supply of the module. If the switch is on, the corresponding indicator will light up.

light extraction: Open/close the laser electronic switch, if the switch is on, the corresponding indicator will light up;

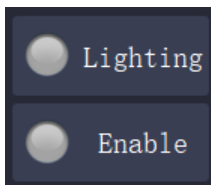

Guide red light: Turn on/off the laser red light. If the switch is on, the red current will be displayed, and the corresponding indicator light will light up;



alarm reset: Send the alarm reset command to the laser, if the laser alarm is lifted, the laser can be reset;



4.3.7 Laser operation flow

- 1, open the micro circuit breaker on the back panel, power on the laser, if everything is normal, open the HL-Monitor series of upper computer software;
2. No alarm is detected inside the laser, and all states are normal;
- 3, input the required frequency and duty cycle;
- 4, input the required power control percentage parameters;
5. Click the enable button, the enable status light is on, and the high voltage on the laser switching power supply is completed;
- 6, click the light button, this time the light state light is lit, and a laser is emitted

4.4 Status interface

Through the upper computer, you can view the state information of the laser and check the state information inside the laser.

4.4.1 Operation page switch: ① module status interface in the figure;



4.4.2 System environment parameters: The position area (6) in the figure includes the parameter information read by the laser temperature and humidity sensor and the status information of the laser external loop

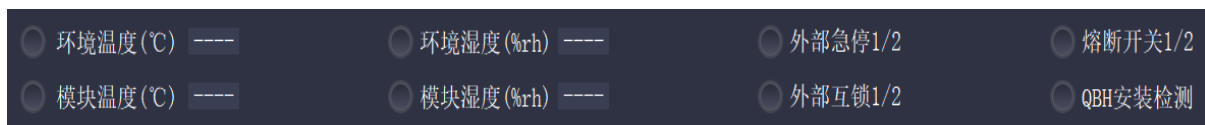

4.4.3 Water temperature inside the machine:



The

position in the figure is the internal water temperature value read by the laser.

4.4.4 QBH Temperature value:



The location area in the

figure is the QBH temperature value read by the laser;

5 MAINTENANCE AND TROUBLESHOOTING

5.1 Troubleshooting

The laser will malfunction when its internal temperature, the output power, and power supply are abnormal, or when INTERLOCK is disconnected. When any fault occurs while the laser is working, fault information will be displayed in the alarm prompt bar on the operation interface, a buzzer signal will go off, and the laser will stop working. Laser lock will not be released until the laser is restarted.

5.1.1 Master Alarms

No.	Alarm Type	Consequence	Solutions
1	Door lock 1 alarm	The laser stops working, and a buzzer signal goes off.	<ol style="list-style-type: none"> 1. Check whether the door plate is open; 2. Check whether the door lock alarm switch is normal; 3. The machine without the door lock device checks whether the door lock configuration is closed;
2	Lock 2 Alert		<ol style="list-style-type: none"> 1. Check whether the door plate is open; 2. Check whether the door lock alarm switch is normal; 3. The machine without the door lock device checks whether the door lock configuration is closed;
3	External Interlock 1		<ol style="list-style-type: none"> 1. Check that the external interlock is properly connected and has signals; 2. Check the external interlock inside the laser to check whether the line is normal;
4	External Interlock 2		<ol style="list-style-type: none"> 1. Check that the external interlock is properly connected and has signals; 2. Check the external interlock inside the laser to check whether the line is normal;
5	Chassis water accumulation alarm		<ol style="list-style-type: none"> 1. Check the inside of the chassis for water leakage; 2. Check the sensor for failure; 3. Check whether the accessories are properly configured without a liquid level sensor;
6	QBH water flow temperature alarm		<ol style="list-style-type: none"> 1. Check whether the QBH water flow is normal; 2. Check the water flow sensor for abnormalities; 3. Check whether the accessories are properly configured when the water flow temperature sensor is not configured;
7	module water flow temperature alarm		<ol style="list-style-type: none"> 1. Check the module water flow is normal; 2. Check the water flow sensor for abnormalities; 3. Check whether the accessories are properly configured

			when the water flow temperature sensor is not configured;
8	Environmental temperature and humidity 1 alarm		<ol style="list-style-type: none"> 1. Checking whether the temperature and humidity are normal; 2. Check the temperature and humidity sensor for abnormality; 3. Check the fitting configuration if the temperature and humidity sensor is not configured;
9	Environmental temperature and humidity 2 alarm		<ol style="list-style-type: none"> 1. Checking whether the temperature and humidity are normal; 2. Check the temperature and humidity sensor for abnormality; 3. Check the fitting configuration if the temperature and humidity sensor is not configured;
10	air conditioner alarm		<ol style="list-style-type: none"> 1. Check whether the air conditioner is abnormal; 2. Check whether the accessories are properly configured when no air conditioning is configured;
11	high voltage lock alarm		<ol style="list-style-type: none"> 1. Whether the high voltage lock switch locks the high voltage;
12	internal emergency		<ol style="list-style-type: none"> 1. whether the emergency stop switch is in the depressed state;
13	high pressure overcurrent 1		<ol style="list-style-type: none"> 1. Check for overcurrent overload of electrical devices; 2. Check that the air switch is off;
14	high pressure overcurrent 2		<ol style="list-style-type: none"> 1. Check for overcurrent overload of electrical devices; 2. Check that the air switch is off;
15	light module alarm		<ol style="list-style-type: none"> 1. Check whether there is light module alarm;
16	Beam Closure Alarm		<ol style="list-style-type: none"> 1. Check whether there is a beam combiner alarm;
17	fuse box alarm		<ol style="list-style-type: none"> 1. Check if there is an alarm for the melting point box
18	external alarm		<ol style="list-style-type: none"> 1. Check if there are other alarms or alarms for other modules

5.1.2 Light Module/Beam Alarm

No.	Alarm Type	Consequence	Solutions
1	temperature alarm	The laser stops working, and a buzzer signal goes off.	<ol style="list-style-type: none"> 1. Check that the temperature value is abnormal 2. Check the temperature sensor for an exception
2	temperature and humidity alarm		<ol style="list-style-type: none"> 1. Check that the temperature and humidity parameter values are abnormal 2. Check whether the temperature and humidity sensor is abnormal; 3. Check if the accessory is configured correctly when no sensor is configured;
3	water flow temperature alarm		<ol style="list-style-type: none"> 1. Check that the water flow parameter value is abnormal 2. Check whether the water and warm water flow sensor is abnormal; 3. Check if the accessory is configured correctly when no sensor is configured;
4	temperature control switch alarm		<ol style="list-style-type: none"> 1. Check whether the temperature exceeds the limit of the temperature control switch; 2. Check whether the temperature control switch sensor switch is abnormal; 3. Check if the accessory is configured properly without a sensor configured;
5	external alarm		<ol style="list-style-type: none"> 1. Check if there are other alarms or alarms for other modules
6	Other Alarms		<ol style="list-style-type: none"> 1. Module internal PD sensor alarm

5.2 Daily Maintenance

It is the customer's responsibility to understand and follow the instructions mentioned in the User Manual. Any damage resulting from incorrect operation will void the warranty. Parts such as accessories and fiber are not covered under the warranty.

- 1) Handle the laser and output head with care as they are easily damaged.
- 2) Keep the inner circulating water clean. Regular maintenance is needed for the cooling system of the chiller. Clean the tank and replace the de-ionized or purified water when it is not clean.
- 3) When a problem with the laser occurs, stop the laser immediately and contact the technical staff of Coractive.

5.3 Maintenance after long inactivity period

If the laser has been turned off for a long time, drain off its water pipe, as scale accumulated in the water pipe may cause blockage and poor heat dissipation, and thus the output power and beam quality would be adversely affected.